



POINT I/O EtherNet/IP Adapter

Catalog numbers 1734-AENT

Table of Contents

Topic	Page
Important User Information	2
Environment and Enclosure	3
Preventing Electrostatic Discharge	3
North American Hazardous Location Approval	4
European Hazardous Location Approval	4
About The Adapter	6
Before You Begin	7
Firmware Backward Compatibility	7
Understand Messaging	7
Configure Autobaud	7
Install the Adapter	8
Set the Network Address	9
Replace The Adapter	11
Wire The Adapter	13
Interpret Status Indicators	15
Specifications	17
Additional Resources	22

Important User Information

Solid-state equipment has operational characteristics differing from those of electromechanical equipment. Safety Guidelines for the Application, Installation and Maintenance of Solid-State Controls (Publication [SGI-1.1](#) available from your local Rockwell Automation sales office or online at <http://www.rockwellautomation.com/literature/>) describes some important differences between solid-state equipment and hard-wired electromechanical devices. Because of this difference, and also because of the wide variety of uses for solid-state equipment, all persons responsible for applying this equipment must satisfy themselves that each intended application of this equipment is acceptable.





In no event will Rockwell Automation, Inc. be responsible or liable for indirect or consequential damages resulting from the use or application of this equipment.

The examples and diagrams in this manual are included solely for illustrative purposes. Because of the many variables and requirements associated with any particular installation, Rockwell Automation, Inc. cannot assume responsibility or liability for actual use based on the examples and diagrams.

No patent liability is assumed by Rockwell Automation, Inc. with respect to use of information, circuits, equipment, or software described in this manual.

Reproduction of the contents of this manual, in whole or in part, without written permission of Rockwell Automation, Inc., is prohibited.

Throughout this manual, when necessary, we use notes to make you aware of safety considerations.

	WARNING: Identifies information about practices or circumstances that can cause an explosion in a hazardous environment, which may lead to personal injury or death, property damage, or economic loss.
	ATTENTION: Identifies information about practices or circumstances that can lead to personal injury or death, property damage, or economic loss. Attentions help you identify a hazard, avoid a hazard and recognize the consequences.
	SHOCK HAZARD: Labels may be on or inside the equipment (for example, drive or motor) to alert people that dangerous voltage may be present.
	BURN HAZARD: Labels may be on or inside the equipment (for example, drive or motor) to alert people that surfaces may reach dangerous temperatures.
IMPORTANT	Identifies information that is critical for successful application and understanding of the product.

Environment and Enclosure



ATTENTION: This equipment is intended for use in a Pollution Degree 2 industrial environment, in overvoltage Category II applications (as defined in EN/IEC 60664-1), at altitudes up to 2000 m (6562 ft) without derating.

This equipment is not intended for use in residential environments and may not provide adequate protection to radio communication services in such environments.

This equipment is supplied as open-type equipment for indoor use. It must be mounted within an enclosure that is suitably designed for those specific environmental conditions that will be present and appropriately designed to prevent personal injury resulting from accessibility to live parts. The enclosure must have suitable flame-retardant properties to prevent or minimize the spread of flame, complying with a flame spread rating of 5VA or be approved for the application if nonmetallic. The interior of the enclosure must be accessible only by the use of a tool. Subsequent sections of this publication may contain more information regarding specific enclosure type ratings that are required to comply with certain product safety certifications.

In addition to this publication, see the following:

- Industrial Automation Wiring and Grounding Guidelines, publication [1770-IN041](#), for more installation requirements.
- NEMA Standard 250 and EN/IEC 60529, as applicable, for explanations of the degrees of protection provided by enclosures.



Preventing Electrostatic Discharge



ATTENTION: This equipment is sensitive to electrostatic discharge, which can cause internal damage and affect normal operation. Follow these guidelines when you handle this equipment:

- Touch a grounded object to discharge potential static.
 - Wear an approved grounding wriststrap.
 - Do not touch connectors or pins on component boards.
 - Do not touch circuit components inside the equipment.
 - Use a static-safe workstation, if available.
 - Store the equipment in appropriate static-safe packaging when not in use.
-

North American Hazardous Location Approval

The following information applies when operating this equipment in hazardous locations:	Informations sur l'utilisation de cet équipement en environnements dangereux:
<p>Products marked "CL I, DIV 2, GP A, B, C, D" are suitable for use in Class I Division 2 Groups A, B, C, D, Hazardous Locations and nonhazardous locations only. Each product is supplied with markings on the rating nameplate indicating the hazardous location temperature code. When combining products within a system, the most adverse temperature code (lowest "T" number) may be used to help determine the overall temperature code of the system. Combinations of equipment in your system are subject to investigation by the local Authority Having Jurisdiction at the time of installation.</p>	<p>Les produits marqués "CL I, DIV 2, GP A, B, C, D" ne conviennent qu'à une utilisation en environnements de Classe I Division 2 Groupes A, B, C, D dangereux et non dangereux. Chaque produit est livré avec des marquages sur sa plaque d'identification qui indiquent le code de température pour les environnements dangereux. Lorsque plusieurs produits sont combinés dans un système, le code de température le plus défavorable (code de température le plus faible) peut être utilisé pour déterminer le code de température global du système. Les combinaisons d'équipements dans le système sont sujettes à inspection par les autorités locales qualifiées au moment de l'installation.</p>
<div style="display: flex; align-items: center;">  <div> <p>EXPLOSION HAZARD</p> <ul style="list-style-type: none"> • Do not disconnect equipment unless power has been removed or the area is known to be nonhazardous. • Do not disconnect connections to this equipment unless power has been removed or the area is known to be nonhazardous. Secure any external connections that mate to this equipment by using screws, sliding latches, threaded connectors, or other means provided with this product. • Substitution of components may impair suitability for Class I, Division 2. </div> </div>	<div style="display: flex; align-items: center;">  <div> <p>RISQUE D'EXPLOSION</p> <ul style="list-style-type: none"> • Couper le courant ou s'assurer que l'environnement est classé non dangereux avant de débrancher l'équipement. • Couper le courant ou s'assurer que l'environnement est classé non dangereux avant de débrancher les connecteurs. Fixer tous les connecteurs externes reliés à cet équipement à l'aide de vis, loquets coulissants, connecteurs filetés ou autres moyens fournis avec ce produit. • La substitution de composants peut rendre cet équipement inadapté à une utilisation en environnement de Classe I, Division 2. </div> </div>

European Hazardous Location Approval

The following applies to products marked **CE** **II 3 G**:

- Are Equipment Group II, Equipment Category 3, and comply with the Essential Health and Safety Requirements relating to the design and construction of such equipment given in Annex II to Directive 2014/34/EU. See the EC Declaration of Conformity at <http://www.rockwellautomation.com/products/certification> for details.
- The type of protection is Ex nA IIC T4 Gc according to EN 60079-15.
- Comply to Standards EN 60079-0:2012+A11:2013, EN 60079-15:2010, reference certificate number DEMKO 04 ATEX 0330347X.
- Are intended for use in areas in which explosive atmospheres caused by gases, vapors, mists, or air are unlikely to occur, or are likely to occur only infrequently and for short periods. Such locations correspond to Zone 2 classification according to ATEX directive 2014/34/EU.



ATTENTION: If this equipment is used in a manner not specified by the manufacturer, the protection provided by the equipment may be impaired.

ATTENTION: Read this document and the documents listed in the Additional Resources section about installation, configuration, and operation of this equipment before you install, configure, operate, or maintain this product. Users are required to familiarize themselves with installation and wiring instructions in addition to requirements of all applicable codes, laws, and standards.

ATTENTION: Installation, adjustments, putting into service, use, assembly, disassembly, and maintenance are required to be carried out by suitably trained personnel in accordance with applicable code of practice.

ATTENTION: In case of malfunction or damage, no attempts at repair should be made. The module should be returned to the manufacturer for repair. Do not dismantle the module.

ATTENTION: This equipment is certified for use only within the surrounding air temperature range of -20...+55 °C (-4...+131 °F). The equipment must not be used outside of this range.

ATTENTION: Use only a soft dry anti-static cloth to wipe down equipment. Do not use any cleaning agents.



WARNING: Special Conditions for Safe Use:

- This equipment is not resistant to sunlight or other sources of UV radiation.
 - This equipment shall be mounted in an ATEX/IECEx Zone 2 certified enclosure with a minimum ingress protection rating of at least IP54 (in accordance with EN/IEC 60079-15) and used in an environment of not more than Pollution Degree 2 (as defined in EN/IEC 60664-1) when applied in Zone 2 environments. The enclosure must be accessible only by the use of a tool.
 - This equipment shall be used within its specified ratings defined by Rockwell Automation.
 - Provision shall be made to prevent the rated voltage from being exceeded by transient disturbances of more than 140% of the peak rated voltage when applied in Zone 2 environments.
 - The instructions in the user manual shall be observed.
 - This equipment must be used only with ATEX certified Rockwell Automation backplanes.
 - Earthing is accomplished through mounting of modules on rail.
 - Devices shall be used in an environment of not more than Pollution Degree 2.
-

About The Adapter

The 1734-AENT POINT I/O™ EtherNet/IP™ Adapter is a communications adapter for POINT I/O modules.

The adapter provides an interface for controlling and communicating with POINT I/O modules from an EtherNet/IP network.

1734-AENT Adapter

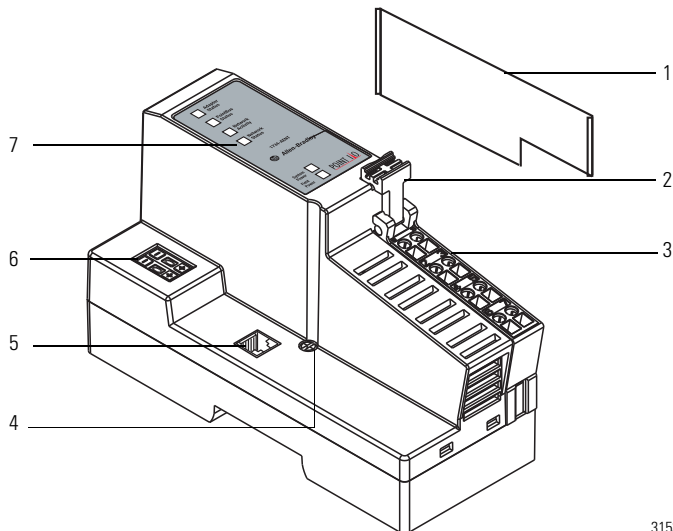

31533

	Description		Description
1	Safety end Cap	5	Ethernet network RJ-45 connector
2	Removable Terminal Block (RTB) handle	6	Network address thumbwheel
3	Removable Terminal Block (RTB)	7	Status indicators
4	DIN rail locking screw (orange)		

Before You Begin

To effectively use your adapter, note the following considerations.

Firmware Backward Compatibility

If using the 1734-AENT adapter with a 1756-ENBT module or 1788-ENBT module, use the following required firmware versions for these bridge modules:

- 1756-ENBT firmware version 2.004 or greater
- 1788-ENBT firmware version 1.033 or greater

If you use the BootP Utility to assign IP addresses to the adapter, use version 2.3.2 or greater.

Understand Messaging

Class 3 (Explicit Message) requests through the 1734-AENT adapter to a specific POINT I/O module do not always receive a response from the I/O modules. Where an I/O module does not reply to a request, the adapter responds with an error code indicating a timeout.

Establish I/O Connections

When you start a POINT I/O system and establish I/O connections, the outputs transition to the Idle state, applying Idle state data before going to Run mode. This occurs even when the controller making the connection is already in Run mode.

Configure Autobaud

The adapter cannot reconfigure an I/O module that you previously configured to operate at a fixed baud rate. When you reuse a POINT I/O module from another POINT I/O system, configure the module to autobaud before using it with the adapter.

Install the Adapter

Follow this procedure to install the adapter on the DIN rail.

Mount the POINT I/O EtherNet/IP Adapter on a DIN Rail

Position the I/O adapter vertically above the DIN rail. Make sure that the DIN rail lock is in horizontal position.

1. Position the adapter vertically above the DIN rail. Make sure that the DIN rail lock is in horizontal position.
2. Press down firmly to install the adapter on a DIN rail, noting that the locking mechanism locks the adapter to the DIN rail.
3. Set the network address thumbwheel switches to the desired value. See [Set the Network Address](#) for more information on setting the IP address.
4. Slide the safety end cap up to remove it, exposing the backplane and power interconnections.



ATTENTION: Do not discard the end cap. Use this end cap to cover the exposed interconnections on the last mounting base on the DIN rail. Failure to do so could result in equipment damage or injury from electric shock.



ATTENTION: This product is grounded through the DIN rail to chassis ground. Use zinc plated chromate-passivated steel DIN rail to assure proper grounding. The use of other DIN rail materials (for example, aluminum or plastic) that can corrode, oxidize, or are poor conductors, can result in improper or intermittent grounding. Secure DIN rail to mounting surface approximately every 200 mm (7.8 in.) and use end-anchors appropriately. Be sure to ground the DIN rail properly. Refer to Industrial Automation Wiring and Grounding Guidelines, Rockwell Automation publication [1770-4.1](#), for more information.



ATTENTION: Allow 25.4 mm (1 in.) of space between adjacent equipment for adequate ventilation.



ATTENTION: Do not remove or replace an Adapter Module while power is applied. Interruption of the backplane can result in unintentional operation or machine motion.



WARNING: If you connect or disconnect the communications cable with power applied to this module or any device on the network, an electrical arc can occur. This could cause an explosion in hazardous location installations.

Be sure that power is removed or the area is nonhazardous before proceeding.

Set the Network Address

The thumbwheel switches are set to 999 and DHCP enabled, by default. You can set the network Internet Protocol (IP) address in the following ways:

- Use the thumbwheel switches on the adapter.
- Use a Dynamic Host Configuration Protocol (DHCP) server, such as Rockwell Automation BootP/DHCP.
- Retrieve the IP address from nonvolatile memory.

The adapter reads the thumbwheel switches first to determine if the switches are set to a valid number. You set the node address by using the 3-position thumbwheel switch. Press the + or - buttons to change the number. Valid settings range from **001...254**.

When you use the thumbwheel switches to assign an address and set it to **001**, the adapter gateway address is set to **0.0.0.0** and the subnet mask is **255.255.255.0**. When you use the thumbwheel to assign an address and set it between **002...254**, the adapter gateway address is set to **192.168.1.1**.

The adapter does not have a host name assigned, or use any Domain Name System when using the thumbwheel settings.

Network Address Thumbwheel

Press either the + or - buttons to change the number and assign the adapter IP address

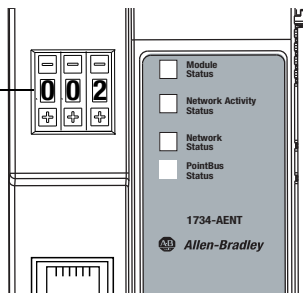

43264

Refer to 1734 POINT I/O EtherNet/IP Adapter User Manual, publication [1734-UM018](#) for more information on configuration settings.

If you set the switches to an invalid number (for example, 000 or a value greater than 254 excluding 888), the adapter checks to see if you enabled DHCP.

DHCP Enabled and Not Enabled

DHCP State	Adapter Action
Enabled	Asks for an address from a DHCP server. The DHCP server also assigns other Transport Control Protocol (TCP) parameters.
Not enabled	Uses the IP address (along with other TCP configurable parameters) stored in nonvolatile memory.



WARNING: When you change switch settings while power is on, an electrical arc can occur. This could cause an explosion in hazardous location installations. Be sure that power is removed or the area is nonhazardous before proceeding.

Replace The Adapter

Use these procedures to install a replacement adapter to an existing system.

1. Disconnect the Ethernet connector(s) from the adapter.
2. Pull up on the Removable Terminal Block (RTB) handle to remove the terminal block.



WARNING: When you insert or remove the module while backplane power is on, an electrical arc can occur. This could cause an explosion in hazardous location installations.

Be sure that power is removed or the area is nonhazardous before proceeding. Repeated electrical arcing causes excessive wear to contacts on both the module and its mating connector. Worn contacts may create electrical resistance that can affect module operation.



WARNING: When you connect or disconnect the Removable Terminal Block (RTB) with field side power applied, an electrical arc can occur. This could cause an explosion in hazardous location installations.

Be sure that power is removed or the area is nonhazardous before proceeding.



WARNING: If you connect or disconnect the communications cable with power applied to this module or any device on the network, an electrical arc can occur. This could cause an explosion in hazardous location installations.

Be sure that power is removed or the area is nonhazardous before proceeding.

-
3. Remove the adjacent module from its base.
 4. Use a small bladed screwdriver to rotate the DIN rail locking screw to a vertical position. This releases the locking mechanism.
 5. Lift straight up to remove.
 6. Slide the safety end cap up to remove it, which exposes the backplane and power connections.
 7. Position the replacement adapter vertically above the DIN rail, making certain the DIN rail lock is in the horizontal position.
 8. Slide the adapter down, allowing the interlocking side pieces to engage the adjacent module.

12 POINT I/O EtherNet/IP Adapter

9. Press firmly to seat the adapter on the DIN rail, noting that the adapter locking mechanism will snap into place.
10. Set the node address on the node address thumbwheel.
11. Insert the end of the terminal block opposite the handle into the base unit, noting that this end has a curved section that engages with the wiring base.
12. Rotate the terminal block into the wiring base until it locks itself into place.
13. Replace the adjacent module in its base.
14. Reconnect the Ethernet cable(s) to the adapter.
15. Set the IP Address for this module.
16. Configure the adapter's chassis size.

Wire The Adapter

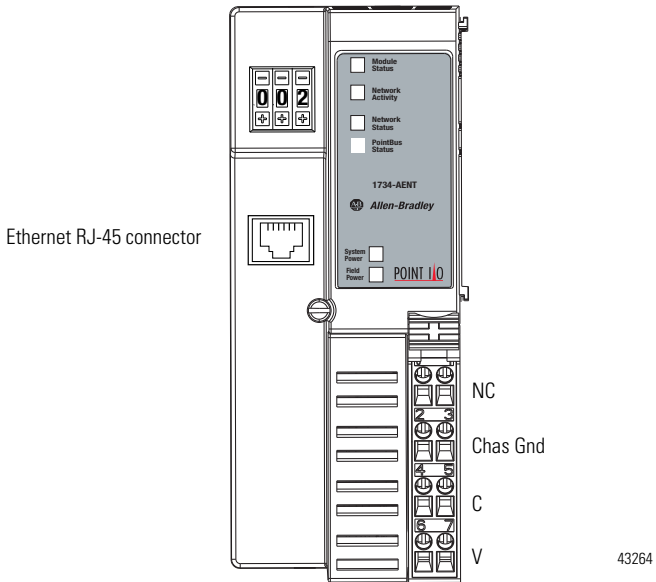

NC = No Connection
 Chas GND = Chassis Ground
 C = Common
 V = Supply

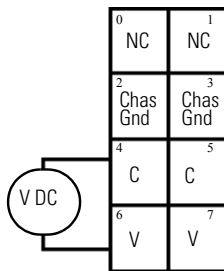

IMPORTANT Do not connect 120/240V AC power to this supply. This DC supply will be connected to the internal power bus.

14 POINT I/O EtherNet/IP Adapter



WARNING: When used in a Class I, Division 2, hazardous location, this equipment must be mounted in a suitable enclosure with proper wiring method that complies with the governing electrical codes.



WARNING: If you connect or disconnect wiring while the field-side power is on, an electrical arc can occur. This could cause an explosion in hazardous location installations. Be sure that power is removed or the area is nonhazardous before proceeding.



WARNING: Do not wire more than two conductors on any single terminal.



WARNING: To comply with the CE Low Voltage Directive (LVD), this equipment must be powered from a Safety Extra Low Voltage (SELV) or Protected Extra Low Voltage (PELV) compliant source.

Interpret Status Indicators

Refer to the following diagram and table for information on how to interpret the status indicators.

Status Indicators

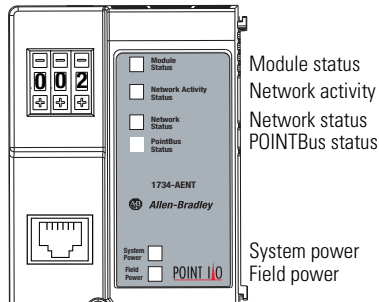

43264

Indicator Status for Modules

Indicator	Status	Description
Module status	Off	No power applied to device
	Flashing green	Device needs commissioning due to missing, incomplete, or incorrect configuration.
	Solid green	Device is operating normally.
	Flashing Red	Recoverable fault. Complete firmware update, verify address switches.
	Solid red	Unrecoverable fault has occurred: <ul style="list-style-type: none"> • Self-test failure present (checksum failure, or RAMtest failure at cycle power). • Firmware fatal error.
	Flashing red/green	Module self-test.
Network activity	Off	No link established.
	Flashing green	Transmit or receive activity present.
	Steady green	Link established.

Indicator Status for Modules

Indicator	Status	Description
Network status	Off	Device not initialized. The module does not have an IP address.
	Flashing green	No CIP connections present. Device has an IP address, but no CIP connections are established.
	Green	CIP connections present. Device online and has an IP address, and CIP connections are established.
	Flashing red	One or more CIP connections in timed-out state. Check for I/O module failure and controller operation. Note: This does not apply to POINTGuard I/O connection timeout.
	Solid red	Duplicate IP address detected. Verify IP address setting and correct, as needed.
	Flashing red/green	The module is performing a self-test (only occurs during cycle power test).
POINTBus status	Off	Device not powered – check module status indicator.
	Flashing red/green	LED cycle power test present.
	Flashing red	Recoverable fault occurred: <ul style="list-style-type: none"> • At cycle power the number of expected modules does not equal the number of modules present • A module is missing • Node fault (I/O connection timeout) occurred.
	Solid red	Unrecoverable fault occurred – the adapter is bus off.
	Flashing green	Firmware (NVS) update in progress.
	Solid green	Adapter online with connections established (normal operation, Run mode).
System power	Off	Not active. Adapter power is off or DC-DC converter problem present.
	Solid green	System power is on. DC-DC converter is active (5V).
Field power	Off	Not active. field power is off.
	Solid green	Power is on. 24V is present.

Specifications

POINT I/O EtherNet/IP Adapter — 1734-AENT

Attribute	Value
Expansion I/O capacity, max	<ul style="list-style-type: none"> • 63 modules • Up to 5 rack-optimization (for digital modules only) and/or enhanced rack-optimization (for digital, analog, and specialty modules) connections • 31 direct connections⁽¹⁾ • 1734-AENT, 1734-AENTK backplane current output = 1.0 A. • Actual number of modules can vary. • Add up current requirements of modules you want to use to make sure they do not exceed the amperage limit of 1.0 A for the 1734-AENT and 1734-AENTK adapter. • Backplane current can be extended beyond 1.0 A by 1734-EP24DC or 1734-EPAC backplane extension power supplies. • Add multiple 1734-EP24DC or 1734-EPAC modules to reach the 63 module max.
POINTBus current requirements, max	<ul style="list-style-type: none"> • 50 mA (Catalog number 1734-IB4D) • 75 mA (Catalog numbers 1734-IB2, 1734-IB4, 1734-IB8, 1734-IV2, 1734-IV4, 1734-OB2, 1734-OB4, 1734-OB8, 1734-OB2E, 1734-OB2EP, 1734-OB4E, 1734-OB8E, 1734-OV2E, 1734-OV4E, 1734-232ASC, 1734-485ASC, 1734-ARM, 1734-IV8, 1734-OV8E, 1734-IE4C, 1734-IE8C, 1734-OE4C, 1734-IA4, 1734-IM4, 1734-OA4, 1734-IR2E, 1734-IE2C, 1734-OE2C, 1734-IE2V, 1734-OE2V, 1734-IA2, 1734-IM2, 1734-OA2) • 80 mA (Catalog number 1734-OW2, 1734-OW4) • 100 mA (Catalog numbers 1734-OX2, 1734-8CFG, 1734-8CFGDLX, 1734-4IOL) • 110 mA (Catalog number 1734-SSI) • 160mA (Catalog numbers 1734-IJ2, 1734-IK2) • 175mA (Catalog number 1734-IT2I) • 180mA (Catalog numbers 1734-VHSC5, 1734-VHSC24) • 220 mA (Catalog number 1734-IR2, 1734-IR2E)
Module location	Starter module - left side of the 1734 system

⁽¹⁾ Maximum 31 direct connections for standard I/O or maximum 20 direct connections if any safety I/O module resides in the backplane.

Power Supply

Attribute	Value
Input voltage rating	24V DC @ 10 A
Input voltage, range	10...28.8V DC
Field side power requirements, max	24V DC @ 400 mA

Power Supply

Attribute	Value
Inrush current, max	6.0A for 10ms
Input overvoltage protection	Reverse polarity protected
POINTBus output current, max	5V DC @ 1.0A
Interruption	Output voltage will stay within specifications when input drops out for 10ms at 10V with maximum load.

Ethernet Communication

Attribute	Value
Ethernet communication rate	10/100 Mbps/s, half or full-duplex
Ethernet ports	1
Ethernet network topologies supported	Star, Tree
Ethernet connector	RJ-45, Category 5
Ethernet cable	Category 5: shielded or unshielded
Ethernet wire connections, max	See Wire Size on page 19.

General Specifications

Attribute	Value
Indicators	3 red/green status indicators (on CPU): – Module status – Network status – POINTBus status 1 green status indicator on CPU: – Network activity 2 green power supply status indicators on DC-DC Converter: – System power (5V DC to POINTBus Out) – Field power (24V DC from Field In)
Power consumption, max	10.4 W @ 28.8V DC
Power dissipation, max	5.2 W @ 28.8V DC
Thermal dissipation, max	17.75 BTU/hr @ 28.8V DC
Isolation voltage	50V (continuous), Reinforced Insulation Type, between all circuits. Type tested at 500V AC for 60 s
Field power supply	10...28.8V DC @ 10A

General Specifications

Attribute	Value
Field power output	10...28.8V DC @ 9A
Module input	10...28V DC @ 1000 mA
POINTBus output, max	5V DC @ 1.0A
Dimensions (HxWxD), approx.	76.2 x 54.9 x 133.4 mm (3.0 x 2.16 x 5.25 in.)
Enclosure type rating	None (open-style)
Terminal base screw torque	0.8 Nm (7 lb-in)
Weight, approx.	255 g (0.56 lb)
Wiring category ^{(1), (2)}	1 – on power ports 1 – on communications ports
Wire Size	Power connections: 0.34... 2.1 mm ² (22...14 AWG) solid or stranded copper wire rated @ 75 °C (167 °F) or greater, 1.2 mm (3/64 in.) insulation max or 90 °C (194 °F) for ControlLogix. Ethernet wiring: RJ45 connector according to IEC 60603-7, 2 or 4 pair Category 5e min cable according to TIA 568-B.1 or Category 5 cable according to ISO/IEC 24702.
North American temp code	T4A
ATEX Temp Code	T4

⁽¹⁾ Use this Conductor Category information for planning conductor routing. Refer to Industrial Automation Wiring and Grounding Guidelines, publication [1770-IN041](#).

⁽²⁾ Use the Conductor Category information for planning conductor routing as described in the appropriate System Level Installation Manual.



At the end of its life, this equipment should be collected separately from any unsorted municipal waste.

Environmental Specifications

Attribute	Value
Temperature, operating	IEC 60068-2-1 (Test Ad, Operating Cold), IEC 60068-2-2 (Test Bd, Operating Dry Heat), IEC 60068-2-14 (Test Nb, Operating Thermal Shock): -20...55 °C (-4...131 °F)
Temperature, surrounding air, max	55 °C (131 °F)
Temperature, nonoperating	IEC60068-2-1 (Test Ab, Unpackaged Nonoperating Cold) IEC60068-2-2 (Test Bb, Unpackaged Nonoperating Dry Heat) IEC60068-2-14 (Test Na, Unpackaged Nonoperating Thermal Shock): -40...85 °C (-40...185 °F)
Relative humidity	IEC 60068-2-30 (Test Db, Unpackaged Damp Heat): 5...95% noncondensing
Vibration	IEC 60068-2-6 (Test Fc, Operating): 5 g @ 10...500 Hz
Shock, operating	IEC 60068-2-27 (Test Ea, Unpackaged Shock) 30 g
Shock, nonoperating	IEC 60068-2-27 (Test Ea, Unpackaged Shock) 50 g
Emissions	IEC 61000-6-4
ESD Immunity	IEC 61000-4-2: 6 kV contact discharges 8 kV air discharges
Radiated RF Immunity	IEC 61000-4-3: 10V/m with 1 kHz sine-wave 80% AM from 30...2000 MHz 10V/m with 200 Hz 50% Pulse 100% AM @ 900 MHz 10V/m with 200 Hz 50% Pulse 100% AM @ 1890 MHz 10V/m with 1 kHz sine-wave 80% AM from 2000...2700 MHz
EFT/B immunity	IEC 61000-4-4: ±4 kV @ 5 kHz on power ports ±3 kV @ 5 kHz on communications ports
Surge transient immunity	IEC 61000-4-5: ±1 kV line-line(DM) and ±2 kV line-earth(CM) on power ports ±2 kV line-earth(CM) on communications ports
Conducted RF Immunity	IEC 61000-4-6: 10Vrms with 1kHz sine-wave 80% AM from 150kHz...80MHz

Certifications

Certification (when product is marked) ⁽¹⁾	Value
c-UL-us	UL Listed Industrial Control Equipment, certified for US and Canada. See UL File E65584. UL Listed for Class I, Division 2 Group A,B,C,D Hazardous Locations, certified for U.S. and Canada. See UL File E194810.
CE	European Union 2014/30/EU EMC Directive, compliant with: EN 61326-1; Meas./Control/Lab., Industrial Requirements EN 61000-6-2; Industrial Immunity EN 61000-6-4; Industrial Emissions EN 61131-2; Programmable Controllers (Clause 8, Zone A & B) European Union 2011/65/Eu RoHS, compliant with: EN 50581; Technical Documentation
RCM	Australian Radiocommunications Act, compliant with: AS/NZS CISPR11; Industrial Emissions
Ex 	European Union 2014/34/EU ATEX Directive, compliant with: EN60079-0:2012+A11: 2013; General Requirements EN60079-15: 2010; Potentially Explosive Atmospheres, Protection "n" II 3 G Ex nA IIC T4 Gc DEMKO 04 ATEX 0330347X
KC	Korean Registration of Broadcasting and Communications Equipment, compliant with: Article 58-2 of Radio Waves Act, Clause 3
EAC	Russian Customs Union TR CU 020/2011 EMC Technical Regulation
EtherNet/IP	ODVA conformance tested to EtherNet/IP specifications

⁽¹⁾ See the Product Certification link at <http://www.rockwellautomation.com/global/certification/overview.page> for Declaration of Conformity, Certificates, and other certification details.

Additional Resources

Resource	Description
1734 POINT I/O EtherNet/IP Adapter User Manual, publication 1734-UM018 .	A detailed description of module functionality, configuration, installation procedure and information on how to use the POINT I/O EtherNet/IP adapter.
Industrial Automation Wiring and Grounding Guidelines, publication 1770-IN041 .	More information on proper wiring and grounding techniques.

If you would like a manual, you can:

- download a free electronic version from the internet:
<http://www.rockwellautomation.com/literature/>
- purchase a printed manual by contacting your local Allen-Bradley distributor or Rockwell Automation representative.

Notes:

Rockwell Automation Support

Rockwell Automation provides technical information on the Web to assist you in using its products. At <http://www.rockwellautomation.com/support/>, you can find technical manuals, a knowledge base of FAQs, technical and application notes, sample code and links to software service packs, and a MySupport feature that you can customize to make the best use of these tools.

For an additional level of technical phone support for installation, configuration and troubleshooting, we offer TechConnect support programs. For more information, contact your local distributor or Rockwell Automation representative, or visit <http://www.rockwellautomation.com/support/>.

Installation Assistance

If you experience a problem within the first 24 hours of installation, please review the information that's contained in this manual. You can also contact a special Customer Support number for initial help in getting your product up and running.

United States or Canada	1.440.646.3434
Outside United States or Canada	Use the Worldwide Locator at http://www.rockwellautomation.com/support/americas/phone_en.html , or contact your local Rockwell Automation representative.

New Product Satisfaction Return

Rockwell Automation tests all of its products to ensure that they are fully operational when shipped from the manufacturing facility. However, if your product is not functioning and needs to be returned, follow these procedures.

United States	Contact your distributor. You must provide a Customer Support case number (call the phone number above to obtain one) to your distributor to complete the return process.
Outside United States	Please contact your local Rockwell Automation representative for the return procedure.

Documentation Feedback

Your comments will help us serve your documentation needs better. If you have any suggestions on how to improve this document, complete this form, publication [RA-DU002](#), available at <http://www.rockwellautomation.com/literature/>.

Rockwell Automation maintains current product environmental information on its website at <http://www.rockwellautomation.com/rockwellautomation/about-us/sustainability-ethics/product-environmental-compliance-page>.

Allen-Bradley, POINT I/O, Rockwell Automation, Rockwell Software, and TechConnect are trademarks of Rockwell Automation, Inc. EtherNet/IP is a trademark of ODVA, Inc.

Trademarks not belonging to Rockwell Automation are property of their respective companies.

Rockwell Otomasyon Ticaret A.Ş., Kar Plaza İş Merkezi E Blok Kat:6 34752 İçerenköy, İstanbul, Tel: +90 (216) 5698400

www.rockwellautomation.com

Power, Control and Information Solutions Headquarters

Americas: Rockwell Automation, 1201 South Second Street, Milwaukee, WI 53204-2496 USA, Tel: (1) 414.382.2000, Fax: (1) 414.382.4444
Europe/Middle East/Africa: Rockwell Automation NV, Pegasus Park, De Kleeflaan 12a, 1831 Diegem, Belgium, Tel: (32) 2 663 0600, Fax: (32) 2 663 0640
Asia Pacific: Rockwell Automation, Level 14, Core F, Cyberport 3, 100 Cyberport Road, Hong Kong, Tel: (852) 2887 4788, Fax: (852) 2508 1846

Publication 1734-IN590C-EN-P - December 2018

Supersedes Publication 1734-IN590B-EN-P - February 2005

Copyright © 2018 Rockwell Automation, Inc. All rights reserved.